

Aus 3mm Rundholz anfertigen

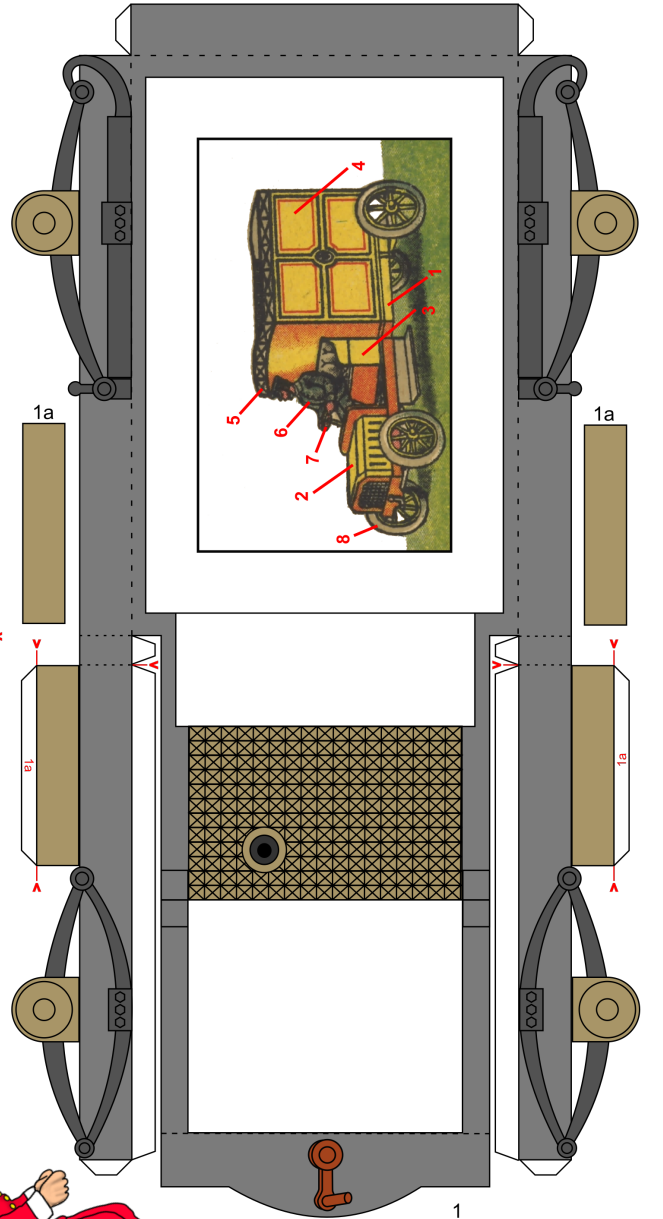

Original: 10115 o.T. Post-Automobil von Oehmigke & Reimschneider vor: 1914, Faksimile: als Download unter <https://www.kartomodellbau.org>, Digitalisierte Neuauflage des Karton-Bastelbogens von Frank-Egon Stoll-Berberich 2020 unter <http://es-b-modellbau.blogspot.com>

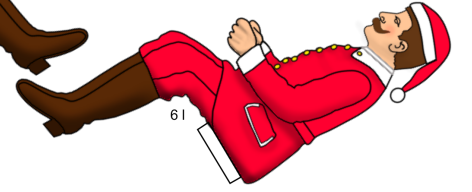
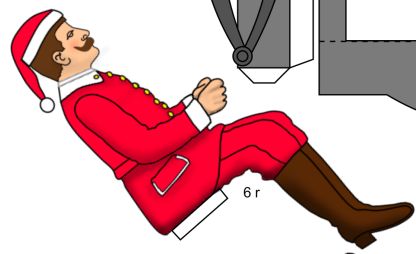
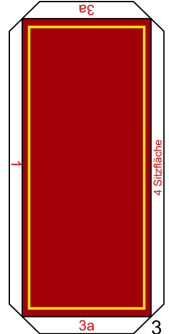
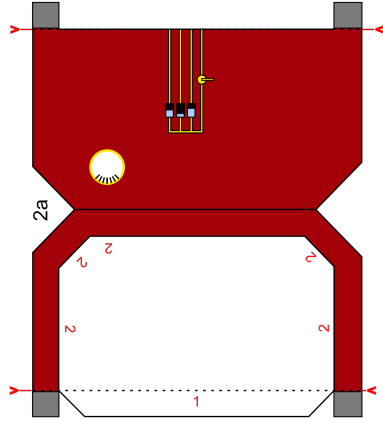
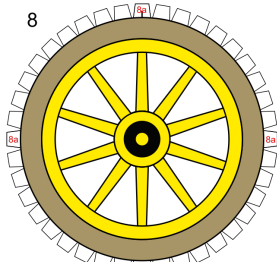
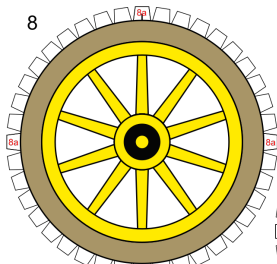
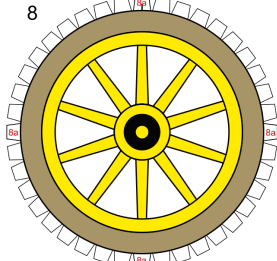
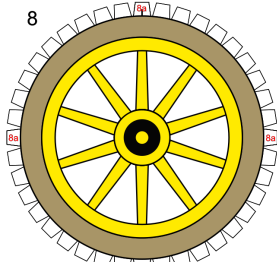
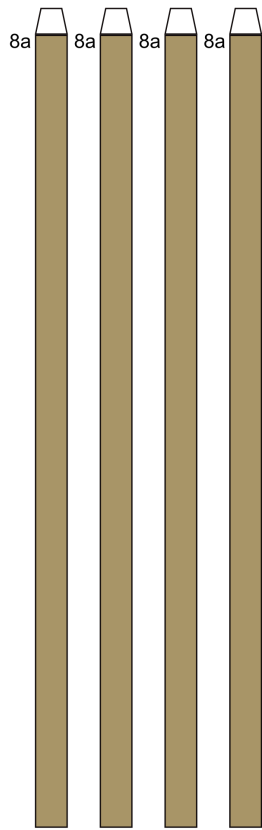
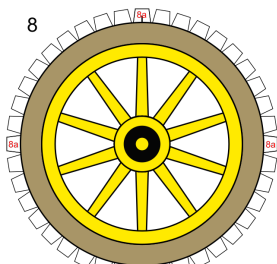

Aus 3mm Rundholz anfertigen

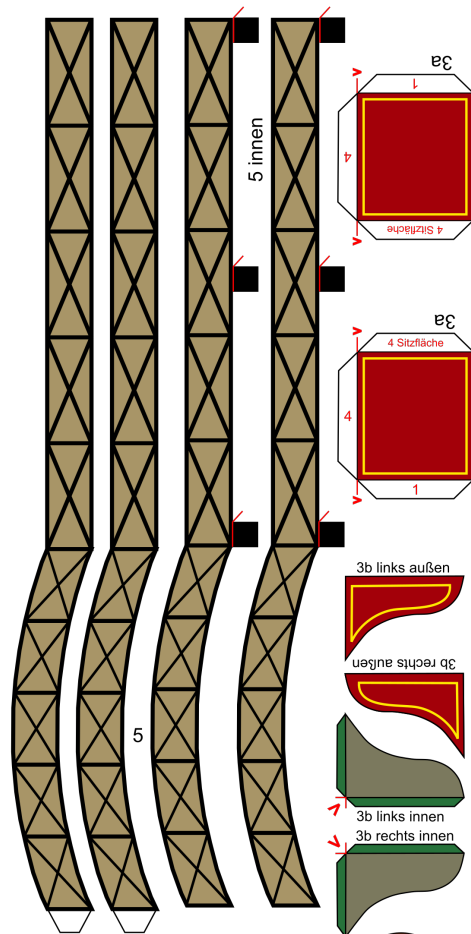
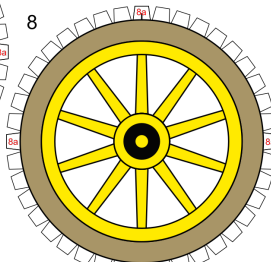

Knickkanten, die mit roter Linie gekennzeichnet sind, werden von der Unterseite angeritzt und nach unten gefaltet

